

EC225

Emergency off and rescue from helicopter



IMPORTANT NOTE

This Ground rescue booklet provided by Airbus Helicopters gives general and safety information on the EC225. This document shall only be considered as a support for users to elaborate their own documentation.

It will not be systematically updated according to aircraft modification process.

Depending on the country and the modification of the helicopter, systems may differ in their location.

CONTENTS

1	GENERAL INFORMATION	3
	MAXIMUM GROSS WEIGHT	3
	OCCUPANCY	3
	DIMENSIONS	3
	POWERPLANTS	4
	FUEL CAPACITY	4
	EXTERNAL FORWARD LUGGAGE CASES or EXTERNAL FORWARD FUEL TANKS (option)	4
	OIL CAPACITY	5
	HYDRAULIC FLUID CAPACITY	5
	COMPOSITE USAGE	6
2	SAFETY INFORMATION - OUTSIDE THE AIRCRAFT	7
	DANGER AREA WITH ROTOR TURNING	7
	EMERGENCY FLOATATION GEAR	7
	PITOTS	8
	LUGGAGE HOLD	8
	FIREFIGHTING RECOMMENDATIONS	9
	GENERAL	9
	FIRE AROUND THE AIRCRAFT	9
	FIRE IN THE FRONT COMPARTMENT	9
	FIRE IN THE ENGINE COMPARTMENT	10
	FIRE IN THE MAIN GEAR BOX (MGB) COMPARTMENT	11
	FIRE IN THE LUGGAGE HOLD	12
	EMERGENCY ACCESS	13
	COCKPIT DOORS	13
	WINDOWS	13
	CABIN DOORS	14
3	SAFETY INFORMATION - INSIDE THE AIRCRAFT	15
	COCKPIT LAYOUT	15
	GENERAL CUT-OUT HANDLES	16
	ELECTRICAL SHUTDOWN	16
	BATTERY	16
	ENGINE SHUTDOWN	17
	ROTOR BRAKING	17
	ENGINE FIRE DETECTION AND EXTINGUISHING SYSTEM	18
	PROCEDURE IN CASE OF ENGINE FIRE DETECTION	19
	SAFETY BELTS	19

1 GENERAL INFORMATION

MAXIMUM GROSS WEIGHT **11000 kg**

- OCCUPANCY**
- One pilot or two pilots
 - Executive: up to 12 passengers
 - Commercial: up to 24 passengers +1 steward
 - OFFSHORE: 2 pilots + up to 19 passengers

DIMENSIONS

Fuselage length: 16.79 m

Fuselage width: 3.96 m

Overall with rotors: 19.50 m

Rotor diameter: 16.20 m

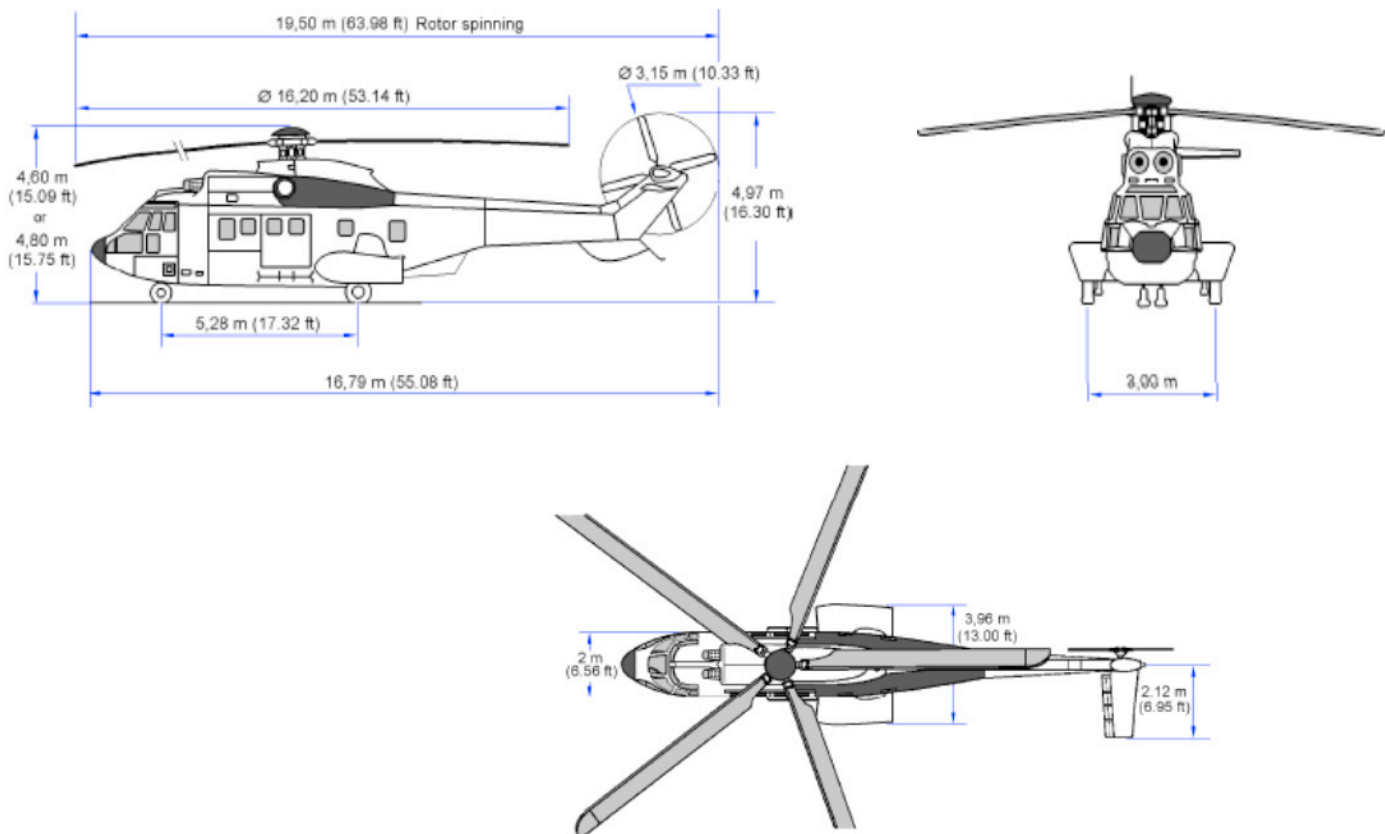

POWERPLANTS MAKILA 2A/2A1 turbine (two)

FUEL CAPACITY Up to 3508 litres

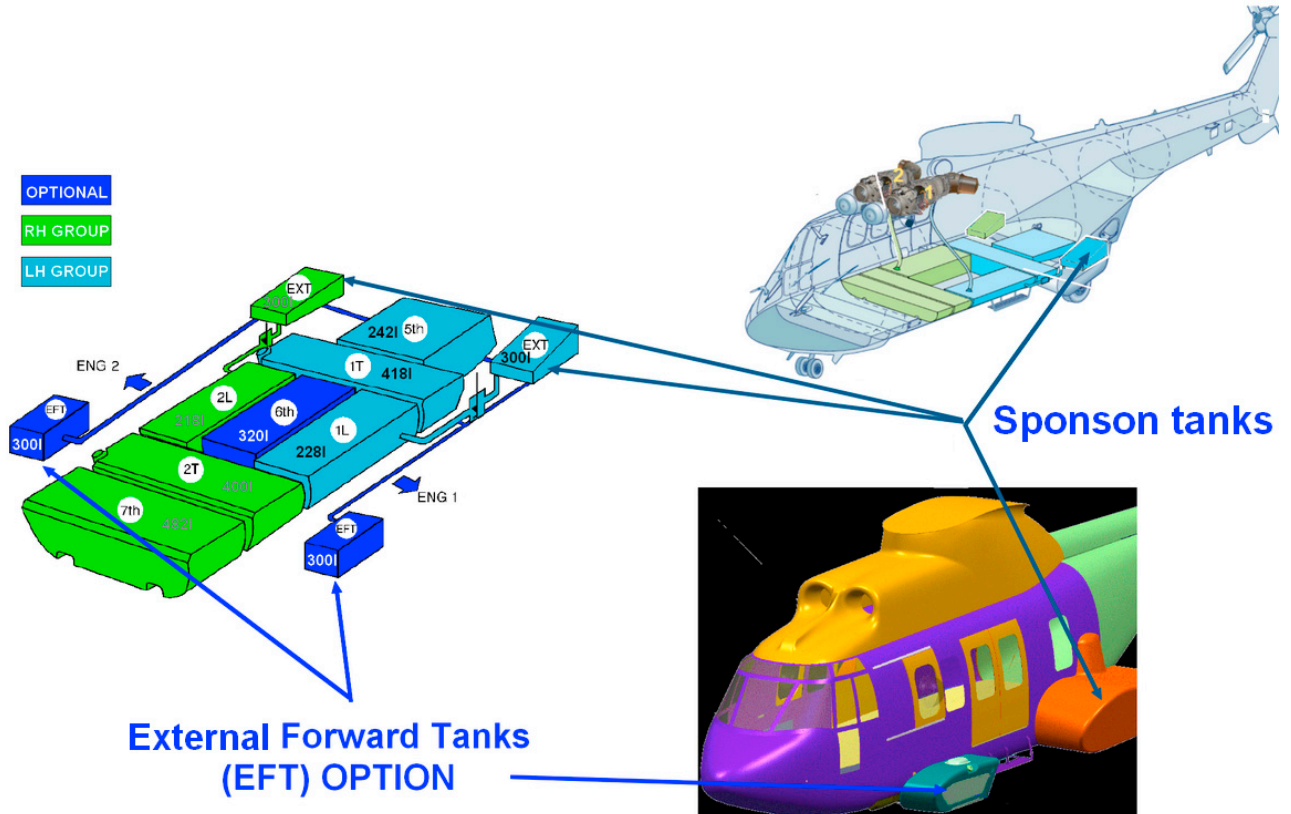

EXTERNAL FORWARD LUGGAGE CASES or EXTERNAL FORWARD FUEL TANKS (option)

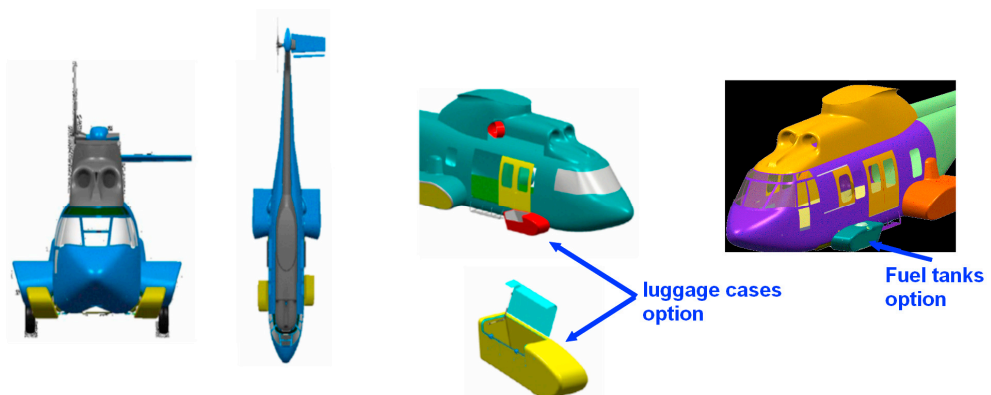

The external forward luggage cases are normally key-locked during the flight.

NOTE: The configuration consists of two luggage cases or two fuel tanks. There is no mixed configuration.

OIL CAPACITY

Engine oil	7.60 l
Main Transmission	21.40 l
Intermediate gear box	0.62 l
Tail gear box	1.44 l

HYDRAULIC FLUID CAPACITY

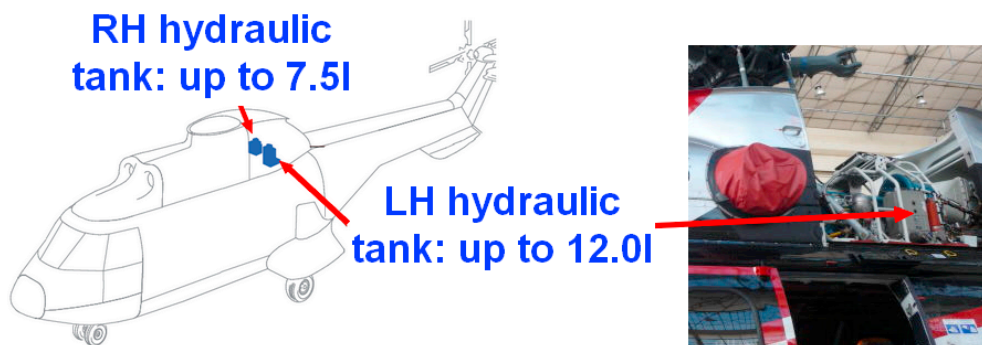

(RH/LH = Right Hand side/Left Hand side)

COMPOSITE USAGE

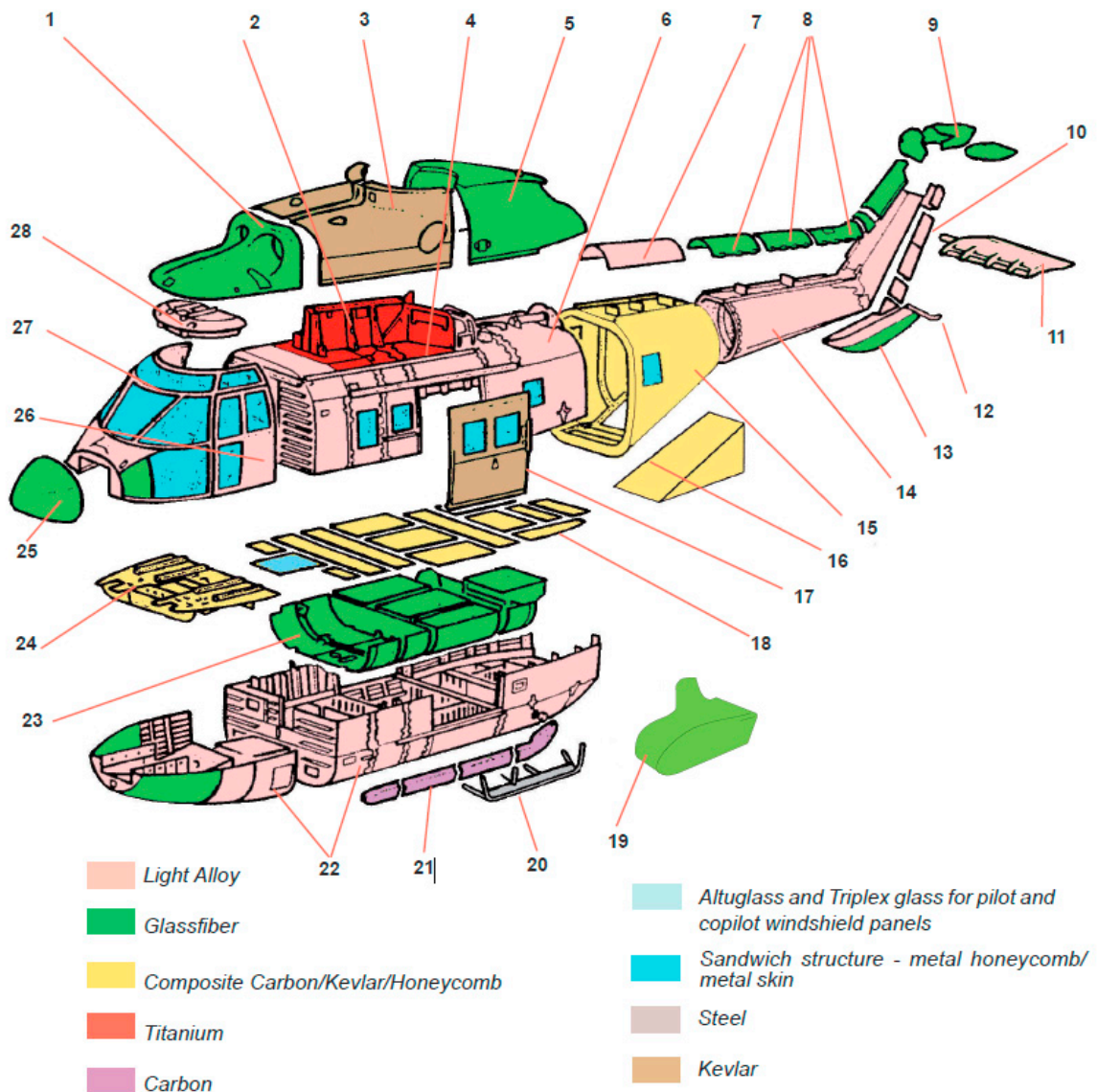

- | | |
|---|--|
| 1 - Air intake sliding cowling | 15 - Intermediate structure |
| 2 - Engine firewall | 16 - Loading hatch |
| 3 - Engine cowling | 17 - Cabin door (RH door opposite hand) |
| 4 - Transmission deck | 18 - Cabin floor |
| 5 - Main Gear Box sliding cowling | 19 - Landing gear fairing |
| 6 - Upper structure | 20 - Footsteps |
| 7 - Tail rotor drive shaft fixed cowling | 21 - Hydraulic line protective channel |
| 8 - Tail rotor drive shaft opening fairings | 22 - Bottom structure |
| 9 - Tail Gear Box fairing | 23 - Fuel tank compartment trimming |
| 10 - Pylon fairings | 24 - Cockpit floor |
| 11 - Horizontal stabilizer | 25 - Radome |
| 12 - Tail skid (steel) | 26 - Copilot's door (Pilot's door opposite hand) |
| 13 - Lower fin | 27 - Canopy |
| 14 - Tail boom | 28 - Forward fixed fairing (cockpit roof) |

2 SAFETY INFORMATION - OUTSIDE THE AIRCRAFT

AIRCRAFT MAY BE CHARGED WITH STATIC ELECTRICITY. USE GLOVES AND IF POSSIBLE DISCHARGE THE AIRCRAFT BY ESTABLISHING AN ELECTRICAL GROUNDING.

DANGER AREA WITH ROTOR TURNING

TAIL ROTOR HEIGHT:Low point 1.85 m

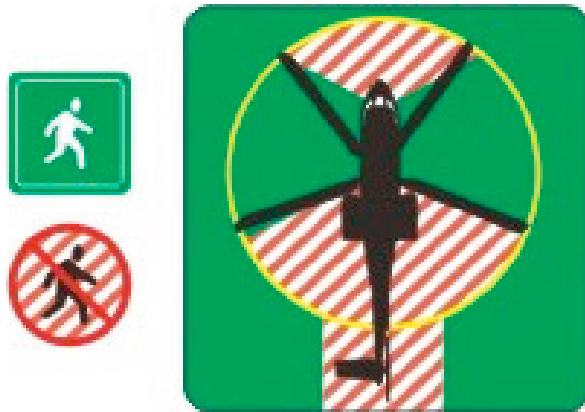

EMERGENCY FLOATATION GEAR

FRONT/SPONSON BALOONS MAY INFLATE.

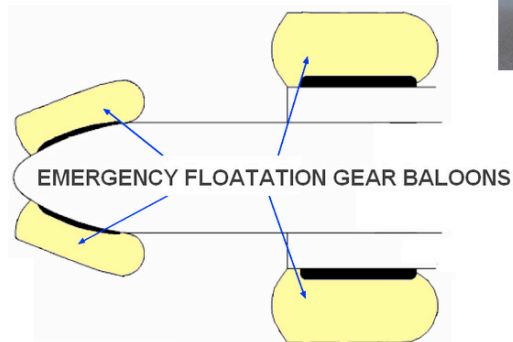

PITOTS

PITOTS ARE HEATED IN FLIGHT AND CAN CAUSE BURNS.



LUGGAGE HOLD

DUE TO THE VICINITY OF THE TAIL ROTOR DO NOT TRY TO OPEN THE STAIRWAY DOOR WHEN THE ROTOR IS SPINNING.

The stairway door of the luggage hold can be opened using the exterior door handle. The luggage hold is equipped with smoke and fire detection.

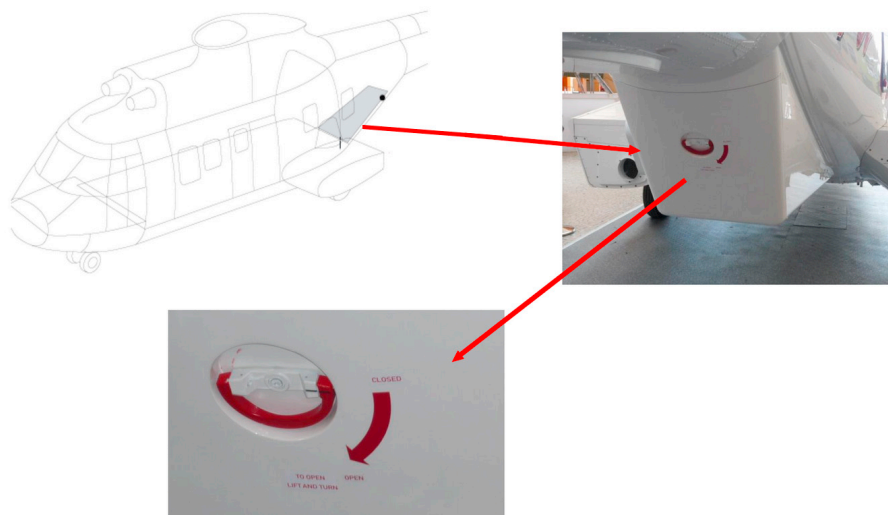

FIREFIGHTING RECOMMENDATIONS

GENERAL

- 1) GROUND STAFF MUST BE IN CONTACT (RADIO / VISUAL SIGNS) WITH THE AIRCREW IN ORDER TO COORDINATE AND SECURE THE INTERVENTION.
- 2) GROUND STAFF MUST WEAR ADEQUATE PROTECTIVE EQUIPMENT.

FIRE AROUND THE AIRCRAFT

If possible wait for the rotor full stop.

FUEL LEAKAGE ALONG THE AIRCRAFT STRUCTURE AND/OR PRESENCE OF FIRE SPILL ON GROUND MUST BE FOUGHT FIRST WITH FOAM.

- Cool with foam or water spray external adjacent structures.

FIRE IN THE FRONT COMPARTMENT

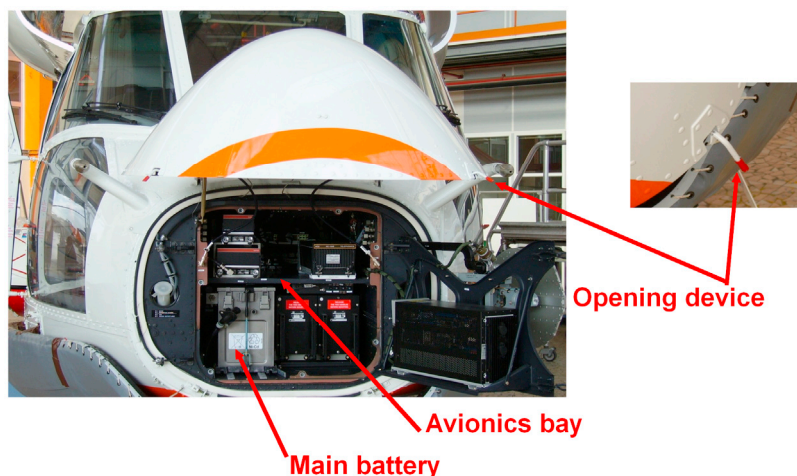

- Slowly open the front compartment (Radome) cowling to avoid a sudden supply of oxygen and a flash-over.
- Saturate the compartment with the extinguishing agent (gaseous extinguisher recommended).

FIRE IN THE ENGINE COMPARTMENT

- 1) WAIT FOR ENGINES AND ROTOR FULL STOP.
- 2) THE TEMPERATURE OF THE ENGINE EXHAUST NOZZLE COULD BE VERY HOT (UP TO 600°C).



- Spray the extinguishing agent (gaseous extinguisher recommended) directly inside the turbine by the engine exhaust nozzle.
- Proceed by circular movements until saturation.

FIRE IN THE MAIN GEAR BOX (MGB) COMPARTMENT

WAIT FOR ENGINES AND ROTOR FULL STOP.

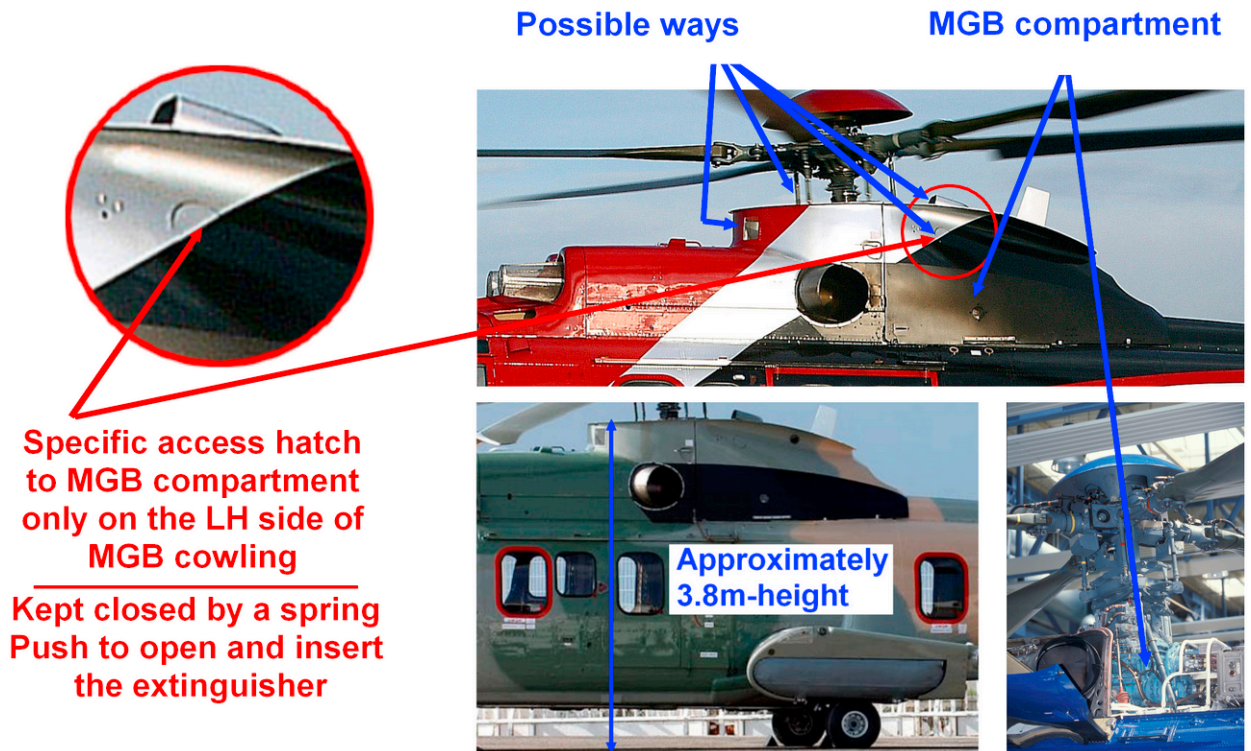

- Spray the extinguishing agent through the easier available way (gaseous extinguisher recommended) for saturating the MGB compartment. Do not try to open the cowlings.
- In case of severe flash-over, use foam.

FIRE IN THE LUGGAGE HOLD

REMINDER: DO NOT TRY TO OPEN THE LUGGAGE HOLD WITH THE ROTORS SPINNING.

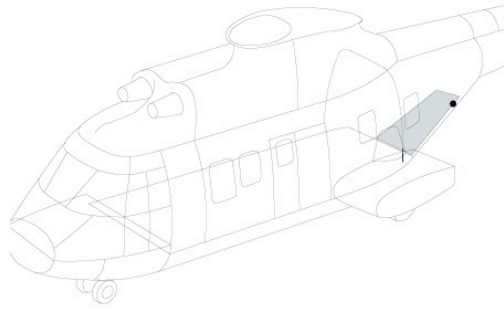

Fight fire using specific holes on the rear bulkhead indicated by the following placards:

FIRE EXTINGUISHING ORIFICE IN BAGGAGE HOLD

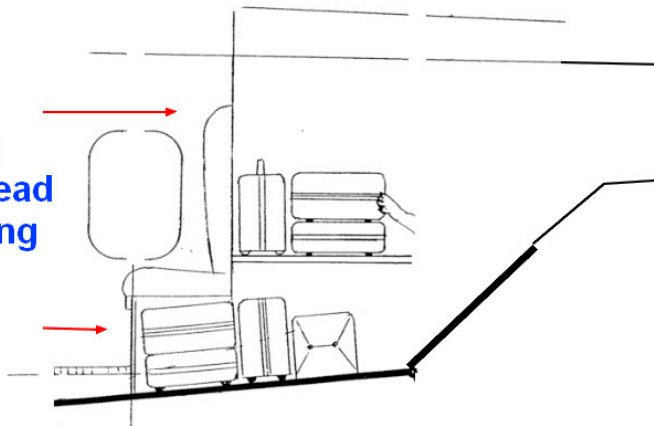

- It is recommended to fight the fire from inside the cabin through the fire extinguishing orifices.
- Saturate the luggage hold with the extinguishing agent (gaseous extinguisher recommended).

EMERGENCY ACCESS

COCKPIT DOORS

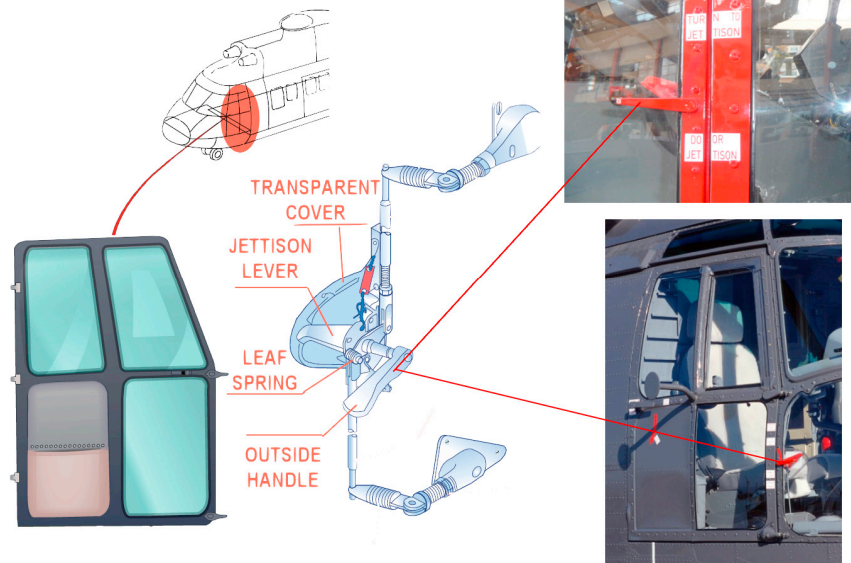

Doors can be jettisoned by actuating the jettison lever, secured by a leaf spring and protected by a breakable transparent cover. It causes the door to fall away. It can be operated from the outside by the outside handle.

WINDOWS

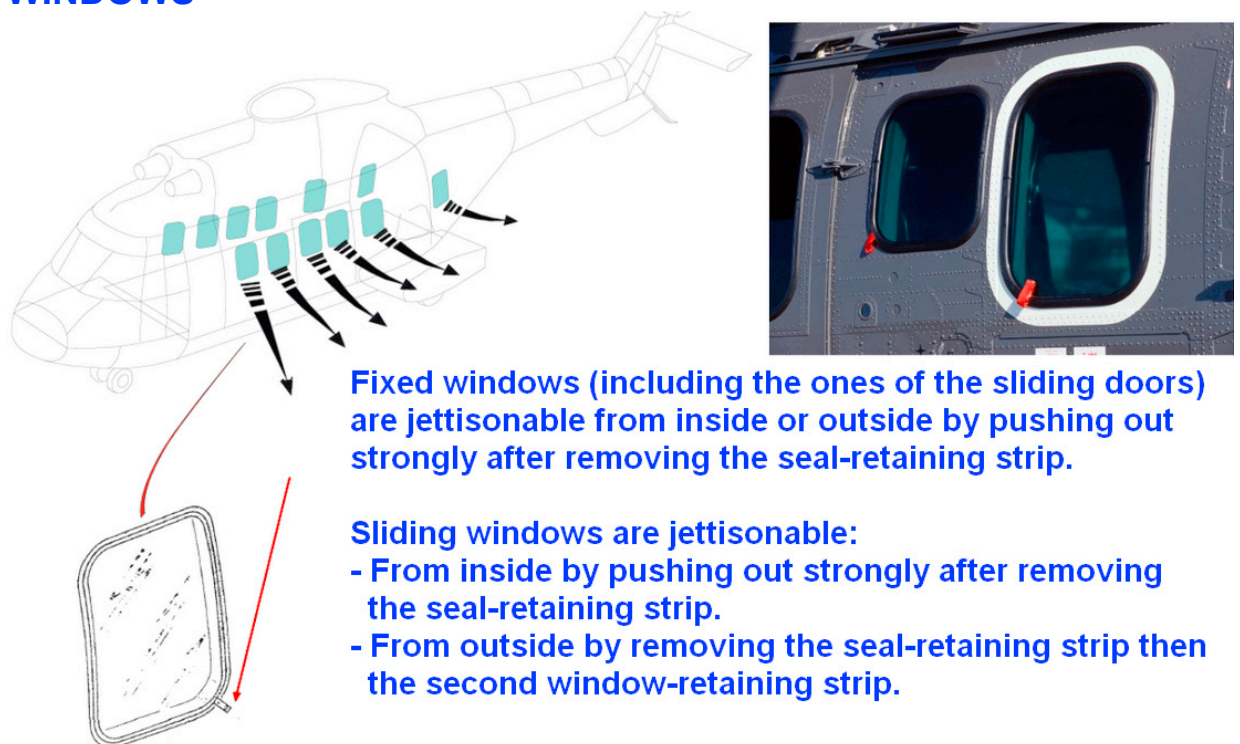

Fixed windows (including the ones of the sliding doors) are jettisonable from inside or outside by pushing out strongly after removing the seal-retaining strip.

Sliding windows are jettisonable:

- From inside by pushing out strongly after removing the seal-retaining strip.
- From outside by removing the seal-retaining strip then the second window-retaining strip.

Bubble windows are bonded to the internal structure and cannot be jettisoned.

CABIN DOORS

DO NOT SLIDE THE DOOR IN CASE OF SOMEONE IS COMING OUT OF A FORWARD WINDOW.

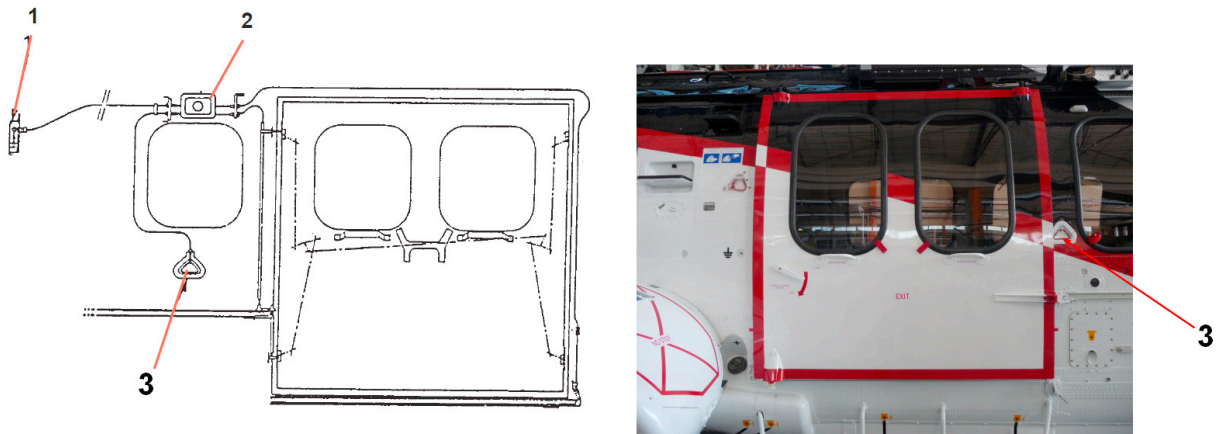

The doors can be jettisoned from two points on the aircraft:

- An actuating handle (2) located next to each door inside the cabin.
- Another jettison handle (3) accessible from the outside of the aircraft.

These two actuating handles are protected by breakable transparent covers.

Two other optional handles (1) can be provided behind the pilot and copilot seats, on the cockpit bulkhead.

3 SAFETY INFORMATION - INSIDE THE AIRCRAFT

COCKPIT LAYOUT

GENERAL
CUT-OUT
HANDLE

ELECTRICAL CONTROL
AND
FIRE EXTINGUISHING PANEL

GENERAL
CUT-OUT
HANDLE

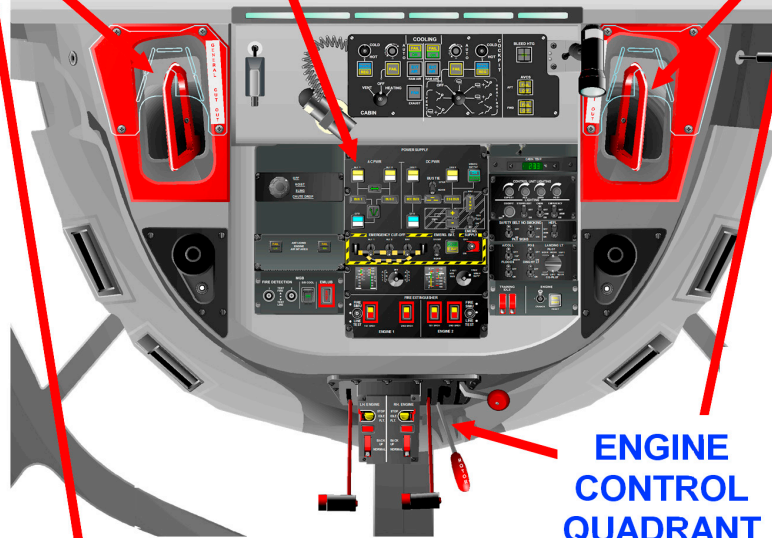

OVERHEAD PANEL

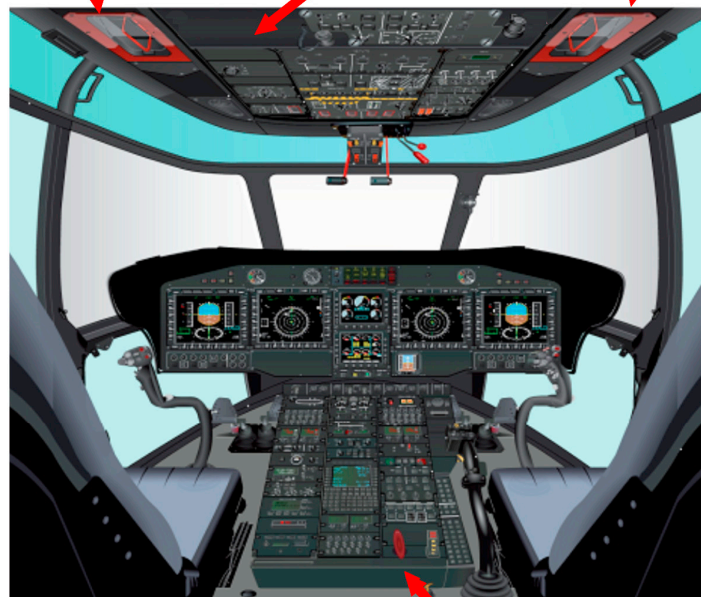

PARKING BRAKE HANDLE

THE FOLLOWING PROCEDURES ARE TO BE USED IN CASE OF EMERGENCY ON GROUND ONLY IF PILOTS ARE INCAPACITATED.

GENERAL CUT-OUT HANDLES

General CUT-OUT handles are located on overhead control panel.

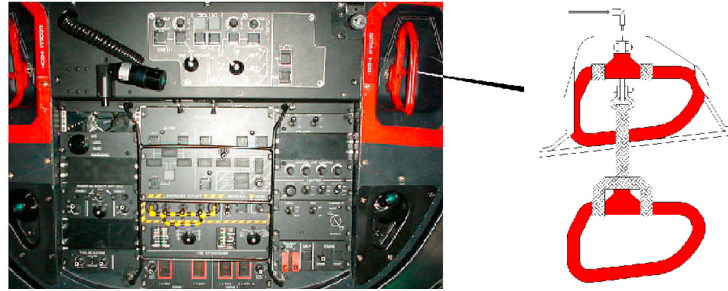

Actuating one general CUT-OUT handles shuts off both engines and cuts off all the electrical supplies except the engine fire extinguishing systems and some necessary items (triple NR indicator...).

ELECTRICAL SHUTDOWN

General CUT-OUT handles or Emergency CUT-OFF on overhead control panel

BATTERY

Main battery is located in the nose (forward avionics compartment).
Emergency battery is located in the baggage hold bulkhead (LH side of fuselage).

OVERHEAD PANEL

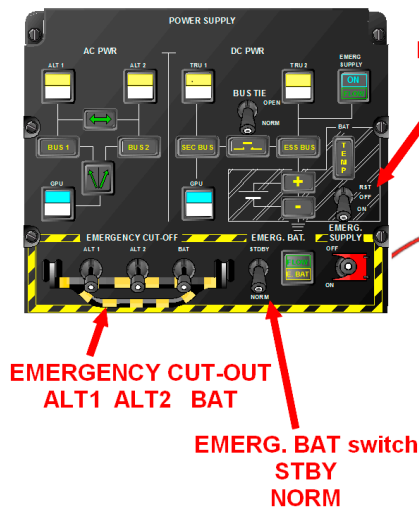

BATTERY switch
RST
OFF
ON



EMERGENCY BATTERY

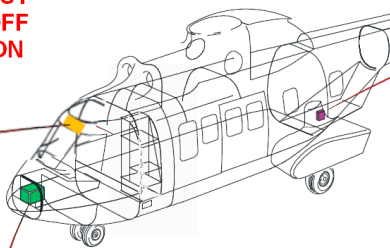

BATTERY

ENGINE SHUTDOWN

- Pull general CUT-OUT handles or,
- Engine **STOP** / IDLE / FLT control switches or,
- LH+RH fuel shut-off levers **rearward**.

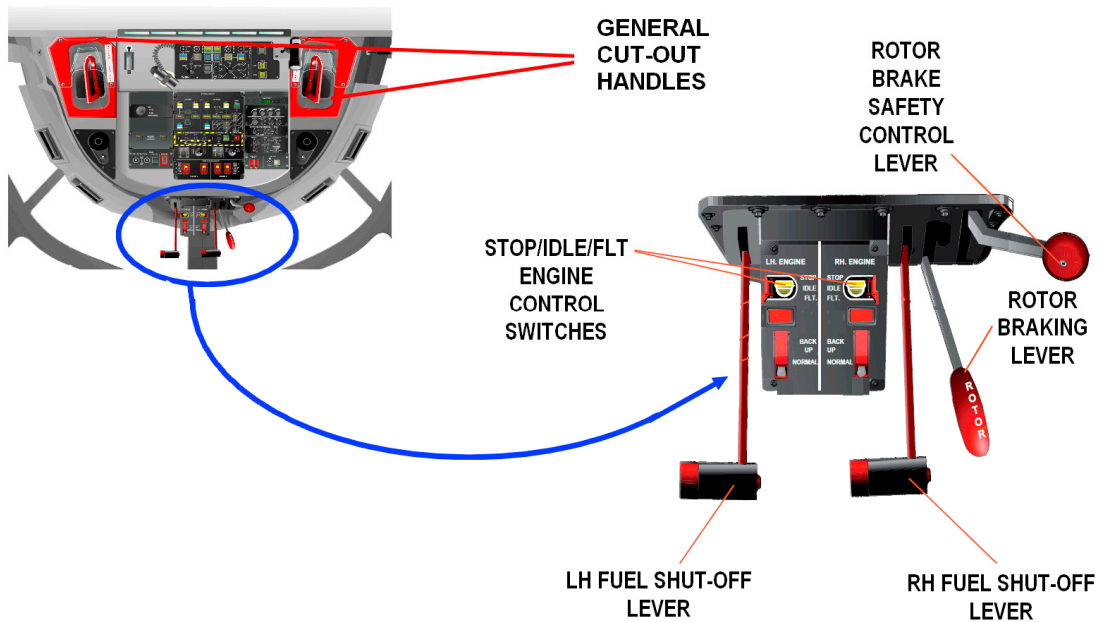

ROTOR BRAKING

ENGINES MUST BE STOPPED BEFORE APPLYING ROTOR BRAKE.

The rotor brake safety control lever shall be in AFT position to enable the rotor braking through the rotor braking lever.



**Max. 45% - 120 rpm
for rotor braking
(white triangle)**

ENGINE FIRE DETECTION AND EXTINGUISHING SYSTEM

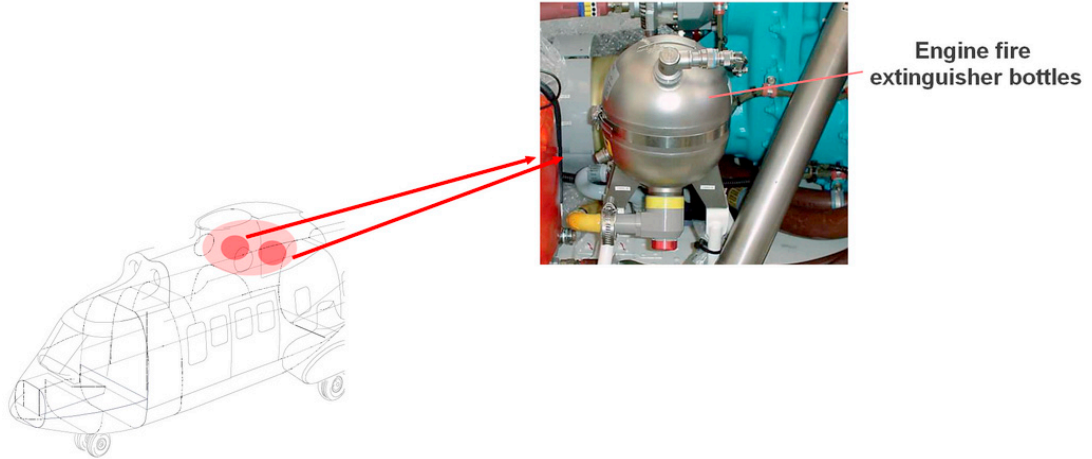

The system consists of detection and extinguishing circuits with two Halon fire extinguishers.

FIRE EXTINGUISHER DISCHARGED INDICATOR LIGHTS

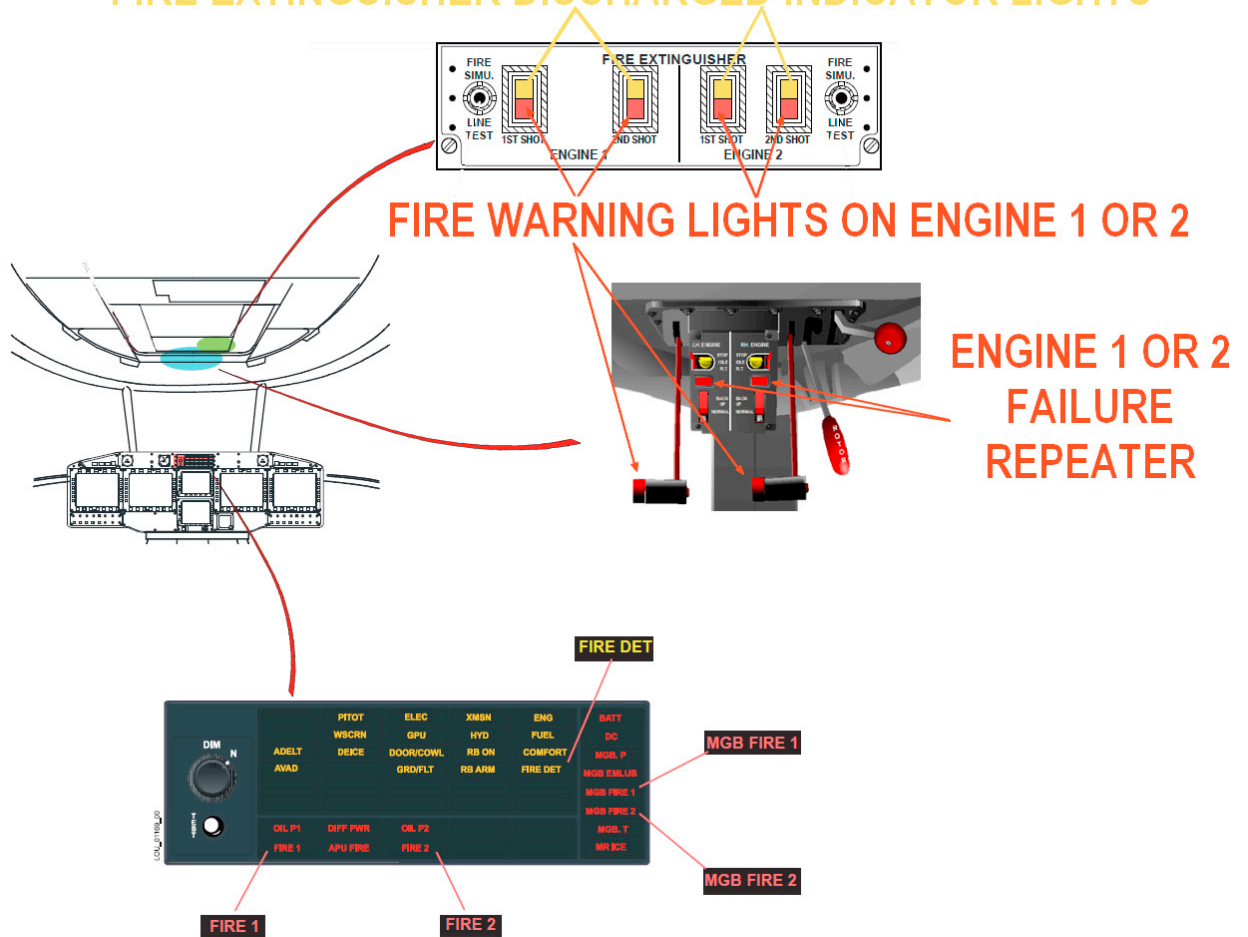

PROCEDURE IN CASE OF ENGINE FIRE DETECTION

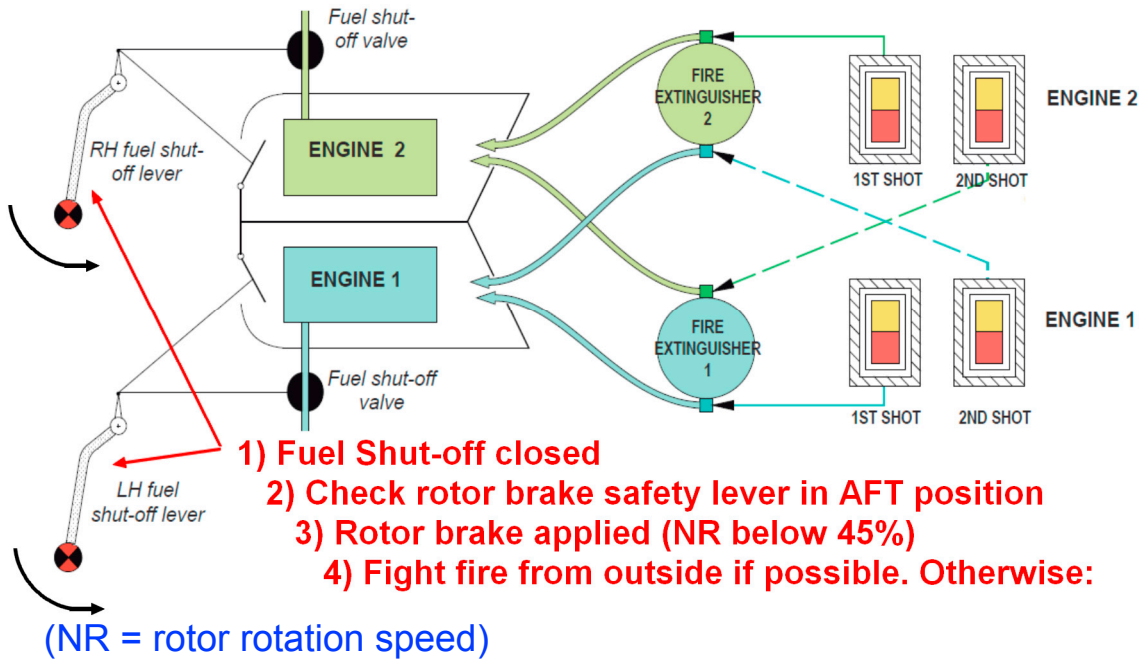

**ON THE AFFECTED ENGINE: PRESS 1ST SHOT.
 THEN IF 1ST SHOT RED LIGHT REMAINS
 ON AFTER A 10S-DELAY:PRESS 2ND SHOT.**

SAFETY BELTS



